

Hot tub internal heater 30 kW

User and maintenance manual

Koriks-Fiiber OÜ

2018

Table of Contents



1 General information	3
1.1 Symbols	3
1.2 Definitions	3
1.3 Warnings	4
1.4 Manufacturer's information	4
2 Intended use	5
3 Transport, assembly, and installation	5
3.1 Transport	5
3.2 Assembly and installation	6
4 Operational use	8
5 Residual risks	10
6 Maintenance	10
7 Warranty	11
8 Contact information	11

1 General information

The product user and maintenance manual includes information about the manufacturer, intended use, handling, transport, assembly, operational use and maintenance of the product.

This manual should be used as a how-to guide during the operation and maintenance of the product.

1.1 Symbols

	<p>DANGER!</p>	<p>Imminent danger!</p>
	<p>CAUTION!</p>	<p>A potentially hazardous situation.</p>
	<p>ATTENTION!</p>	<p>Note!</p>

1.2 Definitions

Product – internal heater for a hot tub.

Handling – transporting, installing or carrying out maintenance work on the product.

Operational use – using the product after correct handling and installation.

Assembly – assembling or installing various parts of the product.

Transport – moving the product from one location to another. Transporting also includes lifting the product from one place to another.

Residual risks – risks that are present during operational use and even after applying safety precautions.

Maintenance – actions related to cleaning, repairing or replacing various parts of the product.

Operator – anyone who is associated with product handling, transport, installation, or maintenance.

Warranty – a period after the product has been sold during which the manufacturer is responsible for the technical condition of the product. The warranty lasts 36 months from the date of purchase.

Internal heater – a heater installed inside the hot tub for heating the water in the hot tub.

1.3 Warnings

Warranty is valid only when this manual and its requirements are followed.

Handling and maintenance may only be performed by operators who have read and understood this manual.

The operators must be at least 18 years of age and must have understood this manual.

The operator must wear safety equipment during all times.

All operations must be stopped immediately if a dangerous situation arises during handling or operational use of the product. Rescue service must be notified if necessary.

All installation and maintenance operations must be done by qualified operators.

If the construction of the product is modified, the product must be tested and approved by the manufacturer or its representative.

During the handling, installation, maintenance, and operational use of this product and its different parts, all necessary state laws / regulations must be considered (in addition to the content of this manual) to ensure the safety of users and the validity of the warranty.

No warranty is provided against damage resulting from reconstruction or modification of the product or use of non-original parts not approved by the manufacturer.

Please contact the manufacturer regarding any questions about this manual.

Please contact the manufacturer regarding any points that are not covered in this manual.

1.4 Manufacturer's information

Koriks-Fiiber OÜ

www.koriks.eu

Reg. No: 10959488

Address: Sooja 6, Saue, Harjumaa 76505

Phone: (+372) 659 6442

2 Intended use

The internal heater is intended for use only outdoors, only in a hot tub, and can be used all year round.

	<p>DANGER!</p>	<p>Using the product indoors is strictly prohibited and might lead to serious injury or death.</p>
---	-----------------------	---

It is prohibited to use the product for unintended purposes.

	<p>ATTENTION!</p>	<p>Using the product for unintended purposes may damage property or the product or cause health hazards.</p>
---	--------------------------	---

	<p>CAUTION!</p>	<p>Use of non-original parts may lead to serious injuries and damage to the product.</p>
--	------------------------	---

The internal heater is intended to be used only outdoors and with the correct hot tub.

3 Transport, assembly and installation

3.1 Transport

The internal heater is delivered on a transport pallet.

After receiving the product make sure that the packaging is not damaged. If the package is damaged, mark the damages on the transport documentation (CMR).

The weight of one package is approximately 21–24 kg.

Remove the plastic and cardboard packaging before assembling and installing the product.

At least two people are needed to lift the heater into the correct position. Use a lifting device if possible.

The internal heater is made of high-quality marine aluminium.

The dimensions of the internal heater are 852 × 810 × 306 mm.

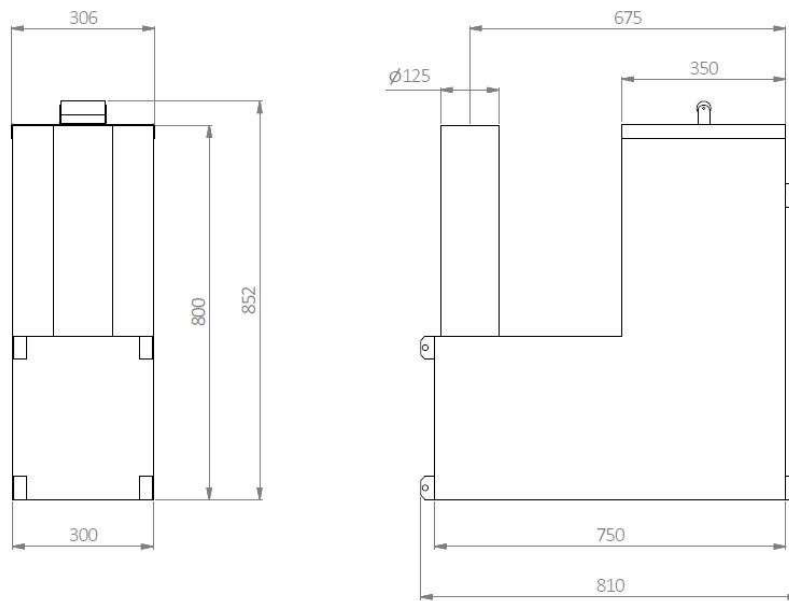

Image 1. General drawing

3.2 Assembly and installation

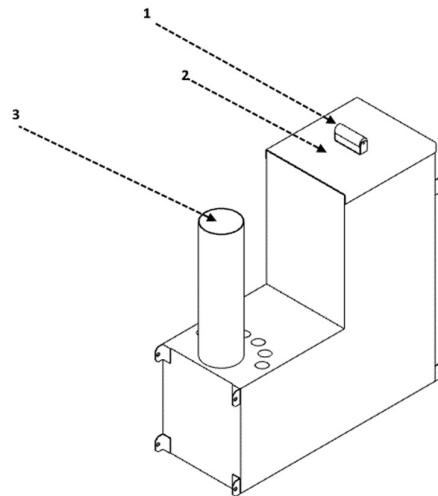

Image 2. Parts of the internal heater

- Heater lid handle (1)
- Heater lid (2)
- Chimney opening (3)

Make sure that the internal heater and chimney are not situated near flammable items/materials.

Safe distances must be consulted on with the local rescue service.

Debris may flow from the heater when filling the hot tub with water for the first time.

Follow the assembly order specified in this manual.

The correct assembly order is as follows.

- Remove the plastic and cardboard packaging from the different parts.
- Install the hot tub on a pre-prepared flat and hard surface.
- The internal heater must be installed in a hot tub. A safety fence can be installed around the internal heater in the hot tub, if necessary.
- Attach the chimney to the internal heater (two parts of the chimney need to be assembled beforehand). See image 3.
- Fill the hot tub with water. No more than 10 cm of water should be absent from the tub.

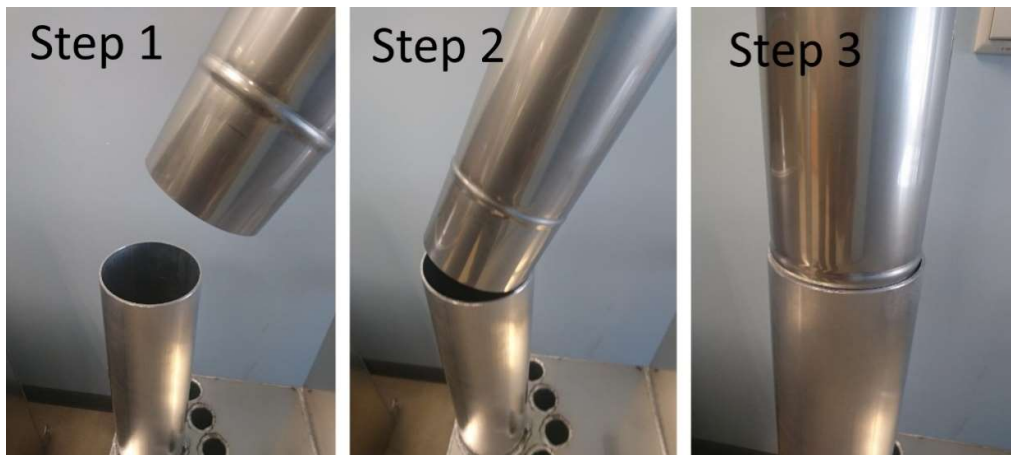

Image 3. Chimney assembly

4 Operational use

Read this manual before operating the internal heater and check the following aspects.

- 1) Make sure installation works have been carried out correctly (following this manual).
- 2) Make sure the hot tub is not leaking.
- 3) Lighting a fire in the heater is allowed only if the tub is filled with water. At the moment of lighting the fire, no more than 10 cm of water should be absent from the tub.

To start a fire, place 4–6 logs of suitable length to into the heater.

You can use paper, woodchips or flammable blocks to light the fire.

When using the heater (when a fire has already been lit in it), the door of the heater may only be opened for adding logs.

During the use of the heater, the heater lid can be left open only by up to 40 mm. See image 4.



Image 4. Maximum lid opening during heater use

	<p>DANGER!</p>	<p>Leaving the internal heater lid open (by more than 40 mm) after adding logs can cause a fire.</p>
---	-----------------------	---

	<p>DANGER!</p>	<p>A fire must not be lit in the internal heater before the hot tub is filled with water.</p>
---	-----------------------	--

	<p>DANGER!</p>	<p>Using fire accelerators such as ignition fluids or other similar fluids and solids is strictly prohibited. This may cause severe injuries or death and damages the product.</p>
---	-----------------------	---

	<p>CAUTION!</p>	<p>Placing objects onto the internal heater is prohibited. Fire hazard!</p>
---	------------------------	--

The internal heater and the chimney will get hot during use and will remain hot for several hours after use. It is prohibited to touch those parts with bare hands. Always use the lid handle when opening the heater lid. See image 5.

Only one adult person should operate the hot tub external heater.

Stir the water from time to time to achieve an evenly distributed water temperature.

The recommended water temperature is around 35–38 °C. Higher water temperatures may cause health problems.

Do not drain the hot tub until the fire in the heater has been extinguished and the coals have cooled down.

Do not let the water freeze in the hot tub during winter.

	<p>CAUTION!</p>	<p>A wrong dose of chlorine may void the warranty.</p>
---	------------------------	---

	<p>CAUTION!</p>	<p>Incorrect maintenance or use may void the warranty.</p>
---	------------------------	---

The power of the internal heater is 30 kW (the temperature of 1 m³ water raises approximately 20 °C/h) and weight 21–24 kg.



Image 5. Correct use of the lid handle

5 Residual risks

Residual risks are risks that remain even after the safety precautions have been applied.

	<p>DANGER!</p>	<p>The internal heater will be hot during use! Do not touch with bare hands. Burning hazard!</p> <p>A safety fence can be installed in front of the internal heater to ensure a safer use of the heater.</p>
---	-----------------------	--

6 Maintenance

The ash pan of the internal heater must be emptied/cleaned after each use using a special ash scoop or ash vacuum.

7 Warranty

The heater has been given a material and production defect warranty for a period of 36 months. The warranty is valid only if the user has read and understood the user and maintenance manual and follows it.

Note! Products designed for commercial use have a different warranty period.

Frost damage is not compensated, as it can be avoided through the correct use of the heater.

Damage caused by extreme weather or other weather phenomena is not covered by the warranty.

Normal wear resulting from the use of the product is not covered by the warranty.

The warranty does not cover corrosive damage resulting from the incorrect use of chemicals.

Unauthorized modifications and repairs or unintended use will void the warranty.

Storing the product in a wrong position or in unsuitable conditions will void the warranty.

The warranty is valid if the buyer informs the manufacturer of the defect within a reasonable time (7 days). The buyer must be able to reliably prove where and when the product was purchased and clearly state the subject matter of the issue.

8 Contact information

Koriks-Fiiber OÜ

Webpage: www.koriks.eu

Email: info@koriks.ee

Address: Sooja 6, Saue, Harjumaa 76505

Phone: (+372) 659 6442