

Pool heater 60 kW

User and maintenance manual

Koriks-Fiiber OÜ

2018

Table of Contents

1 General information	3
1.1 Symbols	3
1.2 Definitions	3
1.3 Warnings	4
1.4 Manufacturer's information	4
2 Intended use	5
3 Transport, assembly and installation	5
3.1 Transport	5
3.2 Assembly and installation	6
4 Operational use	9
5 Residual risks	12
6 Maintenance	12
7 Warranty	12
8 Contact information	13

1 General information

The product user and maintenance manual includes information about the manufacturer, intended use, handling, transport, assembly, operational use and maintenance of the product.

This manual should be used as a how-to guide during the operation and maintenance of the product.

1.1 Symbols

	<p>DANGER!</p>	<p>Imminent danger!</p>
---	-----------------------	--------------------------------

	<p>CAUTION!</p>	<p>A potentially hazardous situation.</p>
---	------------------------	--

	<p>ATTENTION!</p>	<p>Note!</p>
---	--------------------------	---------------------

1.2 Definitions

Product – pool heater.

Handling – transporting, installing or carrying out maintenance work on the product.

Operational use – using the product after correct handling and installation.

Assembly – assembling or installing various parts of the product.

Transport – moving the product from one location to another. Transporting also includes lifting the product from one place to another.

Residual risks – risks that are present during operational use and even after applying safety precautions.

Maintenance – actions related to cleaning, repairing or replacing various parts of the product.

Operator – anyone who is associated with product handling, transport, installation, or maintenance.

Warranty – a period after the product has been sold during which the manufacturer is responsible for the technical condition of the product. The warranty lasts 36 months from the date of purchase.

Pool heater – a heater used to heat the water in a pool.

1.3 Warnings

Warranty is valid only when this manual and its requirements are followed.

Handling and maintenance may only be performed by operators who have read and understood this manual.

The operators must be at least 18 years of age and must have understood this manual.

The operator must wear safety equipment during all times.

All operations must be stopped immediately if a dangerous situation arises during handling or operational use of the product. Rescue service must be notified if necessary.

All installation and maintenance operations must be done by qualified operators.

If the construction of the product is modified, the product must be tested and approved by the manufacturer or its representative.

During the handling, installation, maintenance, and operational use of this product and its different parts, all necessary state laws / regulations must be considered (in addition to the content of this manual) to ensure the safety of users and the validity of the warranty.

No warranty is provided against damage resulting from reconstruction or modification of the product or use of non-original parts not approved by the manufacturer.

Overheating the heater, over-pressurisation or ignoring installation instructions will void the warranty.

Please contact the manufacturer regarding any questions about this manual.

Please contact the manufacturer regarding any points that are not covered in this manual.

1.4 Manufacturer's information

Koriks-Fiiber OÜ

www.koriks.eu

Reg. No: 10959488

Address: Sooja 6, Saue, Harjumaa 76505

Phone: (+372) 659 6442

2 Intended use

The pool heater is intended for use only outdoors and can be used all year round.

	<p>DANGER!</p>	<p>Using the product indoors is strictly prohibited and might lead to serious injury or death.</p>
---	-----------------------	---

It is prohibited to use the product for unintended purposes.

	<p>ATTENTION!</p>	<p>Using the product for unintended purposes may damage property or the product or cause health hazards.</p>
---	--------------------------	---

	<p>CAUTION!</p>	<p>Use of non-original parts may lead to serious injuries and damage to the product.</p>
--	------------------------	---

The pool heater is intended to be used only outdoors and with the correct pool.

3 Transport, assembly and installation

3.1 Transport

The pool heater is delivered on a transport pallet.

After receiving the product make sure that the packaging is not damaged. If the package is damaged, mark the damages on the transport documentation (CMR).

The weight of one package is approximately 75 kg.

Remove the plastic and cardboard packaging before assembling and installing the product.

At least two people are needed to lift the heater into the correct position. Use a lifting device if possible.

The pool heater is made of high-quality 3 mm marine aluminium.

The dimensions of the pool heater are 1400 × 650 mm.

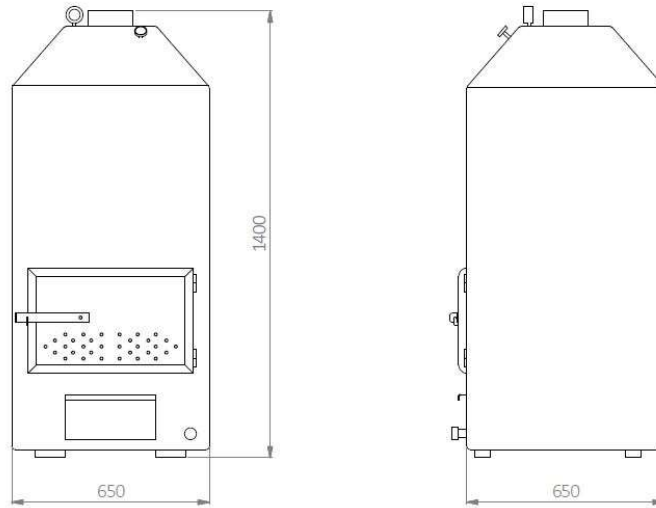

Image 1. General drawing

3.2 Assembly and installation

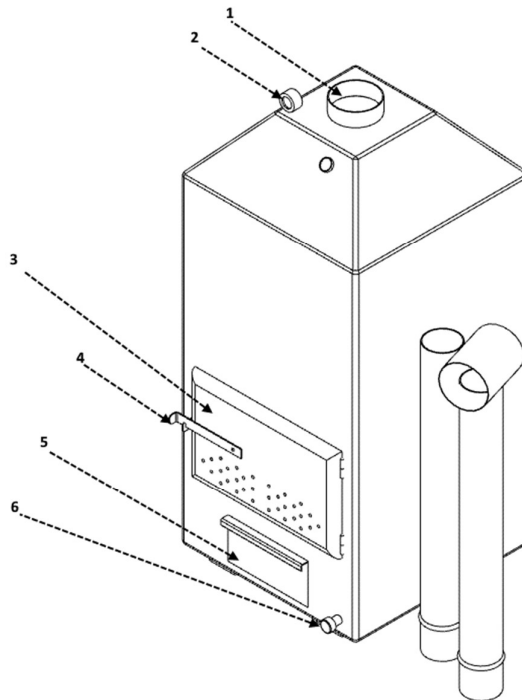

Image 2. Parts of the pool heater

- Chimney opening (1)
- Pressure gauge (2)
- Heater door (3)
- Heater door handle (4)
- Heater ash pan (5)
- Heater drain plug (6)

The heater must be installed by a professional plumber.

Make sure that the pool heater and chimney are not situated near flammable items/materials.

Safe distances must be consulted on with the local rescue service.

Ensure sufficient water circulation before lighting a fire in the heater.

Make sure the threads have been correctly tightened using thread seal tape. The pool heater has standard 1 ½ inch threads. The device must be connected using 1 ½ inch pipes. Using narrower pipes is prohibited.

During installation works make sure that the pool heater inlet is situated on the bottom and the outlet is situated on top.

It is forbidden to install a non-return valve to the heater outlet. Doing so might cause over-pressure and damage welded joints within the heater.

It is recommended to install a one-way valve to the return line.

Chloride levels must be kept within 1–3 ppm. Chloride levels in the pool must never rise above 5 ppm when the heater is connected.

Make sure the circulation pump has been turned on before lighting a fire in the heater.

Make sure the feed from the skimmer and pump basket is open and unobstructed.

Make sure the outlet pressure is approximately 0.2 bar during heating. The pressure must not exceed 0.5 bar. The device must be turned off immediately once the pressure rises above 0.5 bar.

If using a sand filter, it must be installed upstream the heater connection. The heater must be the last element in any pipework system before the water is directed back to the pool as outlet pressure can rise over 1 bar due to sand blockage.

When turning the device on for the first time, a large amount of air will emerge from the pool due to the water flowing into the heater that will replace the air previously in it. This process lasts approximately 2–4 minutes.

Condensation water may drip from the heater door and ash pan at the start of heating. The dripping will stop when the water temperature in the pool has risen.

Fine ash may come out of the chimney when heating for the first time.

If a fire has been lit in the heater, it is forbidden to vacuum or backwash the pool.

The heater must be completely filled with clean water before emptying and disconnecting it. The other option is to fill the heater completely with water and close the door if the heater is left unsupervised for a few hours.

Pump malfunction or a power outage can cause the heater to melt down.

Make sure your home is sufficiently insured against damages caused by such accidents.

Follow the assembly order specified in this manual.

The correct assembly order is as follows.

- Remove the plastic and cardboard packaging from the different parts.
- Install the pool heater on a pre-prepared flat and hard surface.
- The pool heater must be installed by a professional plumber only.
- Connect the heater's 1 ½ inch threads to 1 ½ inch pipes. Using narrower pipes is prohibited.
- Install the pressure gauge to the heater.
- Attach the chimney to the pool heater (two parts of the chimney need to be assembled beforehand). See image 4.
- Install the drain plug at the bottom of the heater. The drain plug must be closed when operating the heater. See image 5.
- Fill the heater with water.
- Open the drain plug gradually whilst monitoring the pressure. If the pressure is high, the heater must be shut down and all outlets checked.



Image 4. Chimney installation



Image 5. Location of the drain plug

4 Operational use

Read this manual before operating the pool heater and check the following aspects.

- 1) Make sure installation works have been carried out correctly (following this manual).
- 2) The pool heater must be filled with water before starting a fire in the heater.
- 3) Make sure the pool heater's drain plug is closed.
- 4) Make sure the pool and the heater are not leaking.
- 5) Make sure the hoses are properly connected.
- 6) Make sure the chlorine level in the pool does not exceed 5 ppm. The ideal range is 1–3 ppm.
- 7) Make sure the outlet pressure is approximately 0.2 bar.
- 8) Make sure chloride has not been added to the skimmer.
- 9) Make sure the fire has gone out in the heater before stopping the pump.
- 10) Make sure the pool heater has water circulation.
- 11) If the heater is not used, empty it and rinse with clean water.

To start a fire, place 4–6 logs of suitable length to into the heater.

You can use paper, woodchips or flammable blocks to light the fire.

When using the heater (when a fire has already been lit in it), the door of the heater may only be opened for adding logs.

	<p>DANGER!</p>	<p>Leaving the pool heater door open after adding logs may cause a fire.</p>
---	-----------------------	---

	<p>DANGER!</p>	<p>A fire must not be lit in the pool heater before the heater is filled with water.</p>
	<p>DANGER!</p>	<p>The heater must have water circulation when heating; otherwise the heater will start to melt.</p>
	<p>DANGER!</p>	<p>Using fire accelerators such as ignition fluids or other similar fluids and solids is strictly prohibited. This may cause severe injuries or death and damages the product.</p>
	<p>CAUTION!</p>	<p>Placing objects onto the pool heater is prohibited. Fire hazard!</p>
	<p>CAUTION!</p>	<p>The heater must be filled with water before lighting the fire!</p>
	<p>CAUTION!</p>	<p>The fire must be completely extinguished before the pump can be turned off.</p>
	<p>CAUTION!</p>	<p>Chloride powder or liquid must not be poured directly into the skimmer. Doing so can damage the pool's devices and lining.</p>

	<p>DANGER!</p>	<p>Shock dosing with chloride is prohibited! Remove the heater from the circulation first.</p>
---	-----------------------	---

The pool heater and the chimney will get hot during use and will remain hot for several hours after use. It is prohibited to touch those parts with bare hands. Always use the door handle when opening the heater door. See image 2 (No. 4).

Only one adult person should operate the heater.

Water circulation must be ensured when using the pool heater.

Stir the water from time to time to achieve an evenly distributed water temperature.

The recommended water temperature is around 35–38 °C. Higher water temperatures may cause health problems.

Do not drain the pool heater until the fire in the heater has been extinguished and the coals have cooled down.

The heater must be emptied of water if it is not being used.

The heater must be properly rinsed with clean water before being stored for winter.

	<p>CAUTION!</p>	<p>A wrong dose of chlorine may void the warranty.</p>
---	------------------------	---

	<p>CAUTION!</p>	<p>Incorrect chloride doses can cause corrosive damage.</p>
---	------------------------	--

	<p>CAUTION!</p>	<p>Incorrect maintenance or use may void the warranty.</p>
---	------------------------	---

The power of the pool heater is 60 kW (the temperature of 11 m³ water raises approximately 5 °C/h) and weight 75 kg.

5 Residual risks

Residual risks are risks that remain even after the safety precautions have been applied.

	<p>DANGER!</p>	<p>The pool heater will be hot during use! Do not touch with bare hands. Burning hazard!</p>
---	-----------------------	---

6 Maintenance

The ash pan of the pool heater must be emptied/cleaned after each use.

The hinges of the pool heater door must be lubricated with heatproof lubrication at least twice a year to ensure unobstructed movement of the door.

7 Warranty

Overheating the heater, over-pressurisation or ignoring installation instructions will void the warranty. Have the heater installed by a professional pool installer, if necessary, and forward them these instructions.

The pool heaters have been given a material and production defect warranty for a period of 36 months. The warranty is valid only if the user has familiarised themselves with the operation and maintenance manual and follows it.

NB! Products designed for commercial use have a different warranty period.

Frost damage is not compensated, as it can be avoided through the correct use of the heater.

Damage caused by extreme weather or other weather phenomena is not covered by the warranty.

Normal wear resulting from the use of the product is not covered by the warranty.

The warranty does not cover corrosive damage resulting from the incorrect use of chemicals.

Unauthorised modifications and repairs or unintended use will void the warranty.

Storing the product in the wrong position or in unsuitable conditions will void the warranty.

The warranty is valid if the buyer informs the manufacturer of the defect within a reasonable time (7 days). The buyer must be able to reliably prove where and when the product was purchased and clearly state the subject matter of the issue.

8 Contact information

Koriks-Fiiber OÜ

Webpage: www.koriks.eu

Email: info@koriks.ee

Address: Sooja 6, Saue, Harjumaa 76505

Phone: (+372) 659 6442